

DECOUPLING ELEMENTS

SDL-*

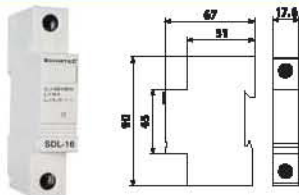

SDL* range are decoupling inductors intended for nominal currents of 16,32,63,80 and 120A. These inductors (sometimes called decoupling impedance) ensure energy coordination between arresters of 1st and 2nd stage or 2nd and 3rd stage arresters according to IEC 61643-1, IEC 1024-1, especially in the places, where there is no adequate distance between arresters (e.g. when there are two following stages placed in one switchboard). A probability arises that arresters of a protection cascade stage could be damaged by lightning current impulse, if the energy coordination is not achieved. If there is at least 10m between following stages (in case of two following stages in two different switchboards), this section impedance can be considered as adequate.

Type		SDL-16	SDL-32	SDL-63	SDL-80	SDL-120
Nominal voltage	U_N	500V/50,60 Hz				
Nominal current	I_N	16A	32A	63A	80A	120A
Inductance	L	6 μ H \pm 10%			4 μ H \pm 10%	6 μ H \pm 10%
DC resistance		<0,01 Ω			<0,001 Ω	
Protection type		IP 20				IP 10
Operating temperature range	ϑ	-40 $^{\circ}$ to + 55 $^{\circ}$ C				
Cross-section of the connected conductors		6+25 mm ² (solid) 6+16 mm ² (flexible) (at tightening moment of clamps 3Nm)		6+35 mm ² (solid) 6+25 mm ² (flexible) (at tightening moment of clamps 3Nm)		16+50 mm ² (solid) 16+35 mm ² (flexible) (at tightening moment of clamps 4Nm)
Mounting on		DIN rail 35mm				
Weight	m	141g	157g	360g	360g	1153g
Installation position		optional				
Lifetime		>100.000 hrs				

Type		SDL-16/15	SDL-32/15	SDL-63/15
Nominal voltage	U_N	500V/50 (60) Hz		
Nominal current	I_N	16A	32A	63A
Inductance	L	15 μ H \pm 10%		
DC resistance		<0,01 Ω		
Protection type		IP 20		
Operating temperature range	ϑ	-40 $^{\circ}$ to +80 $^{\circ}$ C		
Cross-section of the connected conductors (at tightening moment of clamps 3Nm)		6+25mm ² (solid) 6+16mm ² (flexible)		6+35mm ² (solid) 6+25mm ² (flexible)
Mounting on		DIN rail 35mm		
Weight	m	157g	330g	630g
Installation position		optional		
Lifetime		>100.000 hrs		

POWER SUPPLY SYSTEMS SURGE ARRESTER CLASS III

SDL-*HFF

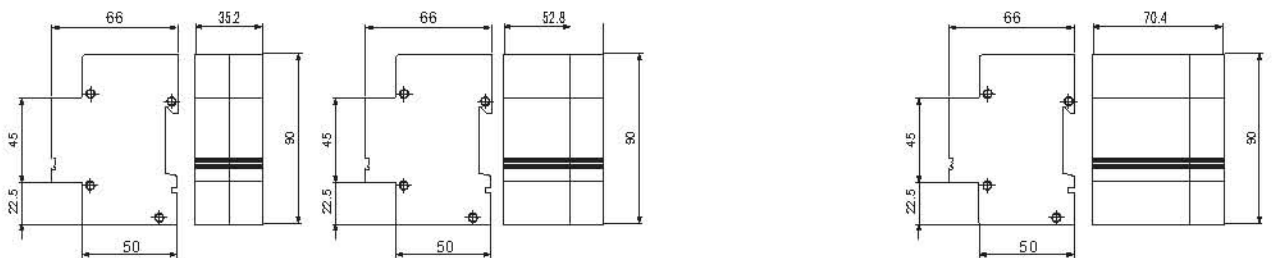

* This complex range is produced in two versions for $U_N = 6, 12, 24, 48, 60, 80, 110, 120, 130, 160$, and $230V(AC/DC)$

SDL-*HFF range are two stage, single-phase surge protection devices with a high-frequency filter. They are designed for protection of electronic appliances in L.V. supply systems against impulse surge and against high-frequency disturbance. The filters are constructed for mounting on DIN rail 35mm for nominal currents 8, 16, 25 and 32 A according to IEC 61643-1 and EN 61643-11 standards (arrester class III-3rd stage protection). SDL-*HFF range is equipped with max. discharge current $I_{max} = 8kA(8/20)$, $t_A < 25ns$ and a special core with extremely high permeability $\mu > 80000$. This complex range is produced in two versions for $U_N = 6, 12, 24, 48, 60, 80, 110, 120, 130, 160$ and $230V(AC/DC)$. The types SDL-8HFF, SDL-16HFF, SDL-25HFF, SDL-32HFF are fitted with a green led diode, which signalizes the right functioning. The types SDL-16HFFDS and SDL-25HFFDS indicate the failure by target disconnection of mechanical thermal fuses, which react to varistors (non-linear elements) overheating above c. $120^\circ C$. If any of the two fitted thermal fuses react, remote controlling potential-free contact FAILURE disconnects at the same time.

POWER SUPPLY SYSTEMS SURGE ARRESTER CLASS III

Type		SDL-8HFF	SDL-16HFF	SDL-16HFFS	SDL-25HFFS	SDL-25HFF	SDL-32HFF
Test class acc. to IEC/EN		III / IT3					
Nominal voltage	U_N	230/50 (60) Hz					
Max. continuous operating voltage	U_c	275V/50 (60) Hz					
Nominal current	I_N	8A	16A		25A		32A
Continuous operat. current	I_c	c.2mA		c. 50 μ A		c.2mA	
Nominal discharge current $I_n(8/20)$	I_n	3 kA (L→N, L→PE) 5 kA (L→PE)					
Combined impulse	U_{oc}	6 kV(L→N, L→PE) 10 kA (N→PE)					
Voltage protection level at U_{oc}	U_p	≤ 850 V (L→N) $\leq 1,5$ V (L→PE) $\leq 0,5$ V (N→PE)					
Recommended back up fuse		8A	16A		25A		32A
Response time	t_A	<25 ns(L→N) <100 ns (L→PE, N→PE)					
Recomm. Cross-section of connected conductors		2,5÷4mm ²	4÷6mm ²		6÷10mm ²		
Operating temperature range	ϑ	-40°to + 55°C					
Protection type		IP 20					
Housing material		SLOVAMID 6FRC2					
Mounting on		DIN rail 35 mm					
Asymmetrical attenuation of filter (band-stop filter) 0,15 to 30 MHz		Min. 80dB at 4MHz Min. 40dB in band 0,15 to÷30 MHz					
Filter constants	C_x C_y L	150nF	220nF				
		22nF					
		1,2 mH	1,8mH		2,3mH		
Power loss at winding temperature 20°C		$<2,2$ W	$<3,5$ W				<4 W
Potential free signal contact		El.strength against surround. circuits 3750V_{rms} El.strength against network circuit 3750V_{rms} Insulation resistance 2x10⁷Ω Max. switching current ~0,5 A Max. switching voltage ~250V					
Life time		min 100.000 hrs					
Weight	m	130g	166g	235g			

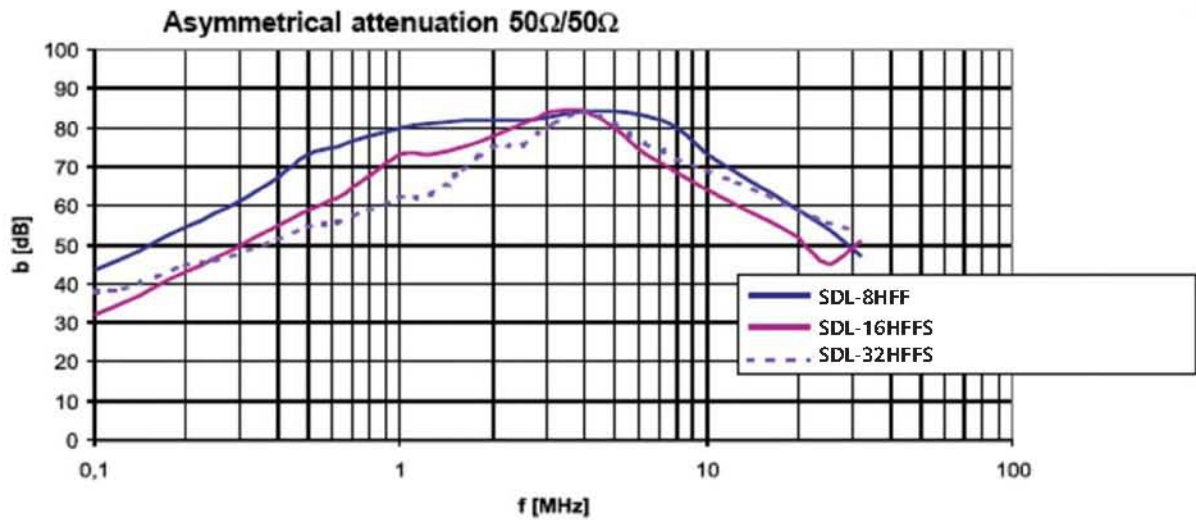

Basic circuit diagram of SDL-8HFF , SDL-16HFF , SDL-25HFF , SDL32HFF

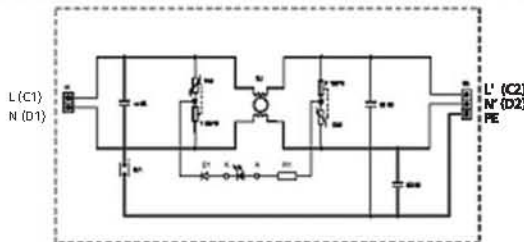

Basic circuit diagram of SDL-25HFF , SDL-32HFFDS

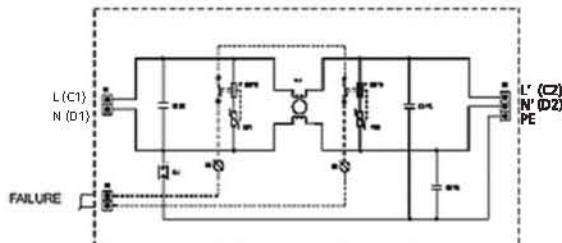

Recommended connection of SDL-^xHFF"

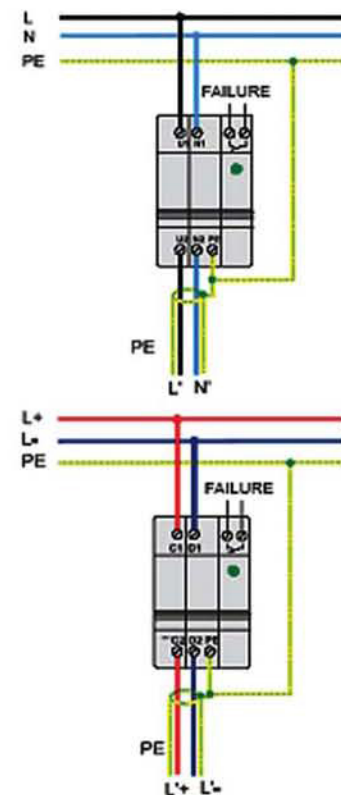

It is recommended to connect protected appliance by appropriately dimensioned shielding conductor. Types of voltages: $U_N = 6, 12, 24, 48, 60, 80, 110, 120, 130$ and 160 V(AC/DC) can be produced when a special order is placed.

The filter contains non-linear elements (varistors and gas discharge tubes), that is why it is necessary to disconnect the filter during controlling of switchboard and measuring of insulation resistance of L.V. supply system.

Recommended cross-section for grounding	
SDL-8HFF	2,5 mm ² Cu
SDL-16HFF	4 mm ² Cu
SDL-25HFF	6 mm ² Cu
SDL-32HFF	6 mm ² Cu

POWER SUPPLY SYSTEMS SURGE ARRESTER CLASS III

SDL-*HFF



SDL-*HFF range are two stage, single-phase surge protection devices with a high-frequency filter. They are designed for protection of electronic appliances in L.V. supply systems against impulse surge and against high-frequency disturbance. The filters are constructed for mounting on DIN rail 35mm or they can be fitted straight onto construction of switchboard by four screws M4. They are intended for currents $I_N=32,50,63, 80,120$ and $150A$ and $U_N= 6,12,24,48,60,80,110,120,130,160$ and $230V(AC/DC)$. They apply to the standards IEC 61643-1 and EN 61643-11 (Class III-3rd stage protection). SDL-*HFF range is equipped with special varistors with response time $t_A < 25ns$ and a special core with extremely high permeability $\mu > 80.000$. Function failure of non-linear elements - varistors are indicated by target disconnection of mechanical thermal fuses, which react to varistors overheating above c. $120^\circ C$. If any of the two fitted thermal fuses react, the remote monitoring potential-free contact FAILURE disconnects at the same time.

Type		SDL-32HFF	SDL-50HFF	SDL-63HFF	SDL-80HFF	SDL-120HFFS	SDL-150HFFS
Test class according to IEC/EN		III / T3					
Nominal voltage	U_N	230V/50(60) Hz					
Max. continuous operating voltage	U_C	275V/50(60) Hz					
Nominal current	I_N	32A	50A	63A	80A	120A	150A
Nominal discharge current $I_n(8/20)$	I_n	3 kA (L→N, L→PE) 5 kA (N→PE)					
Voltage protection level at U_{oc}	U_P	$\leq 850 V$ (L→N) $\leq 1,5 kV$ (L→PE) $< 500V$ (N→PE)					
Combined impulse	U_{oc}	6 kV (L→N, L→PE) 10 kV (N→PE)					
Response time	t_A	$< 25ns$ (L→N) $< 100ns$ (L→PE, N→PE)					
Cross-section of connected conductors		10mm ²	25mm ²			35mm ²	
Operating temperature range	ϑ	-40° to $+ 55^\circ C$					
Protection type		IP 10					
Housing material		Metal sheet 0,8 mm					
Mounting on		DIN rail 35 mm or by screws M4 on chassis					
Asymmetrical attenuation of filter (band-stop filter) 0,15 to 30 MHz		Min. 80dB at 3MHz Min. 40dB in band 0,15 to 30 MHz				Min. 80dB at 2MHz Min. 30dB in band 0,15 to 30 MHz.	
Filter constants	C_x C_y L R	M68				2M	
		22 nF					
		2,2 mH		1,4mH	1mH	0,6mH	
		820k Ω					
Power loss at winding temperature 20°C		<5W	<7W	<9W	<12W	<20W	<20W
Potential free signal contact		El. strength against surround. circuits El. strength against network circuit Insulation resistance Max. switching current Max. switching voltage				3750V _{rms} 3750V _{rms} 2x10 ⁷ Ω -0,5 A -250 V	
Life time		min 100.000 hrs					
Weight	m	870g	968g		1033g	1374g	1493g

* They are Intended for currents $I_N=32,50,63,80,120$ and $150A$ and $U_N =6,12,24,48,60,80,110,120,130,160$ and $230V(AC/DC)$.

Asymmetrical attenuation 50Ω/50Ω

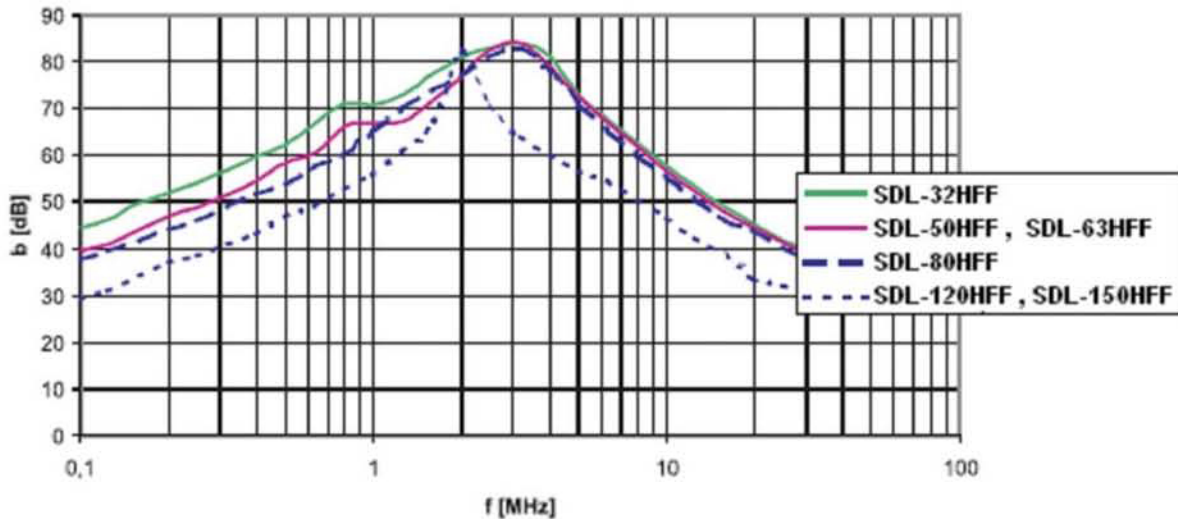

Recommended connection of SDL-*HFF

System TNS

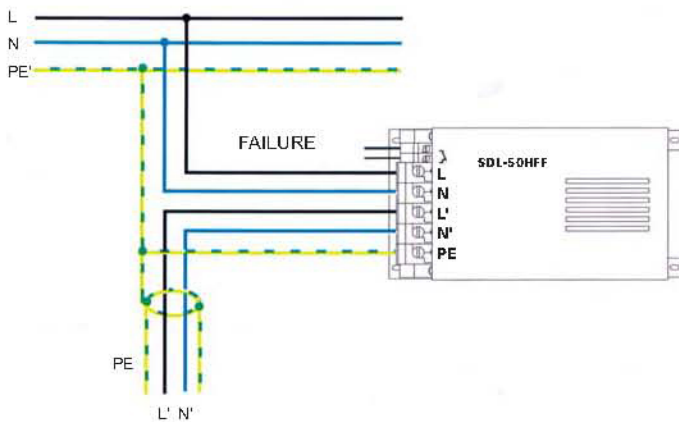

System DC

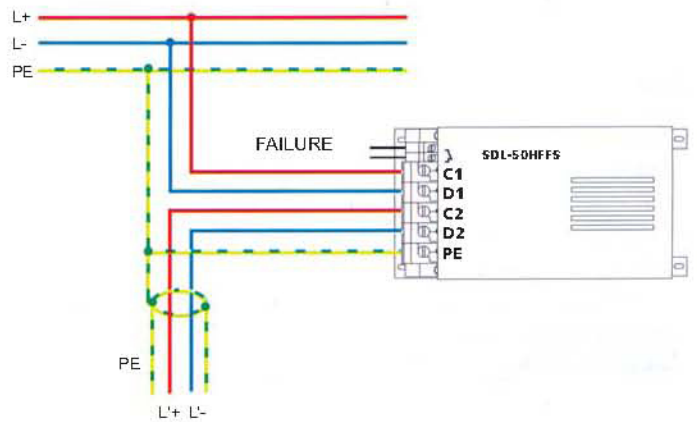

Surge arresters SDL-32HFF,SDL-50HFF,SDL-63HFF,SDL-80HFF,SDL-120HFF,SDL-150HFF in basic version are designed for mounting on chassis with the help of 4 screws M4.If mounting on DIN rail is required, it is necessary to specify the requirement in the order - horizontal/vertical mounting (e.g. SDL-50HFF/DIN/H or SDL-50HFF/DIN/V).

It is necessary to ensure that the ventilation holes in the box of SDL-32HFF,SDL-50HFF,SDL-63HFF,SDL-80HFF,SDL-120HFF,SDL-150HFF are not covered.

It is recommended to connect protected appliance by appropriately dimensioned shielding conductor. The filter contains non-linear elements (varistors and gas discharge tubes),that is why it is necessary to disconnect the filter during controlling of switchboard and measuring of isolation resistance of L.V. supply system.

POWER SUPPLY SYSTEMS SURGE ARRESTER CLASS III

SDL-3*HFF

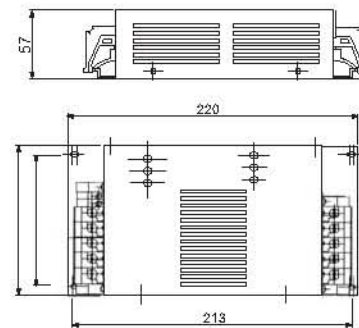
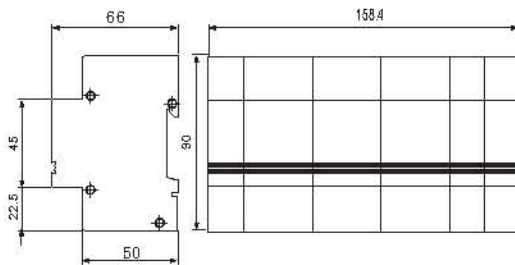

A complex range of two-stage, three-phase surge protection devices with a high-frequency filter. They are designed for protection of electronic equipment in L.V. three phase supply systems against impulse overvoltage and high-frequency disturbance. They are intended for nominal currents 16,25,32,50 and 80A for applications in TNS, TNC, TT and IT systems according to IEC 61643-1 and EN 61643-11 standards. All devices are constructed to be mounted on DIN rail 35 mm, it is possible to fit the filters intended for 32,50,63 with 4 screws straight onto chassis of switchboard. The devices are equipped with special varistors with discharge ability $I_{max}(8/20)=8kA$, response time $t_A < 25ns$ and a special core with extremely high permeability of $\mu > 80000$. Function failure of non-linear elements - varistors is indicated by target disconnection of mechanical thermal fuses, which react to varistors overheating above c. $120^\circ C$. If any of the six fitted thermal fuses react, remote controlling potential-free contact FAILURE disconnects at the same time.

**POWER SUPPLY
SYSTEMS SURGE ARRESTER
CLASS III**

Type		SDL-316HFF	SDL-325HFF	SDL-332HFF	SDL-350HFF	SDL-363HFF	SDL-380HFF
Test class according to IEC/EN		III / T3					
Nominal voltage	U_N	3x400/230V/50(60) Hz					
Max.continuous operating voltage	U_C	3x480/275V/50(60) Hz					
Nominal current	I_N	16A	25A	32A	50A	63A	80A
Nominal discharge current $I_n(8/20)$	I_n	3 kA (L→N, L→PE) 5 kA (L→PE)					
Combined impulse	U_{oc}	6 kV (L→N,L→PE) 10 kV (N→PE)					
Voltage protection level at U_{oc}	U_P	≤ 850 V (L→N) ≤ 1,5 kV (L→PE) ≤ 0,5 kV (N→PE)					
Recommended back up fuse		16A	25A	32A	50A	63A	80A
Response time	t_A	<25ns(L→N) <100ns (L→PE, N→PE)					
Cross-section of connected conductors		4+6mm ²		10mm ²	25mm ²		
Operating temperature range	ϑ	-40°to + 55°C					
Protection type		IP 20			IP 10		
Housing material		SLOVAMID 6FRC2			sheet metal 0,8 mm		
Mounting on		DIN rail 35 mm			DIN rail 35 mm or by screws M4 on chassis		
Asymmetrical attenuation of filter (band-stop filter) 0,15 to 30 MHz		Min. 80dB at 2MHz			min. 80dB at 1,5 MHz Min. 40dB in band 0,15 to 30 MHz		
Filter constants	C_{x1}	-			M15		
	C_{x2}	M33			M68		
	C_y	2x47 nF					
	L	1,3 mH	1,4mH	2,15 mH		1mH	0,9 mH
	R	820kΩ					
Power loss at winding temperature 20°C		<7,5W	<10W	<8W	<9W	<13W	<15W
Potential free signal contact		El.strength against surround. circuits 3750V _{rms} El.strength against network circuit 3750V _{rms} Insulation resistance 2x10 ⁷ Ω Max. switching current ~0,5A Max. switching voltage ~250V					
Life time		min 100.000 hrs					
Weight	m	494g		1400g	1600g		1710g

POWER SUPPLY SYSTEMS SURGE ARRESTER CLASS III

Recommended connection of SDL-3*HFF

System TNS

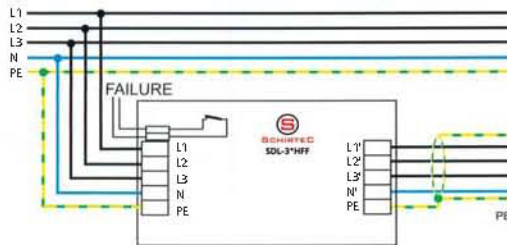

System TT

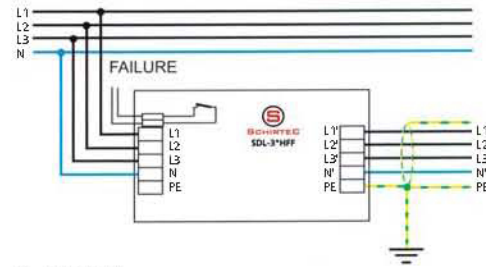

System TNC

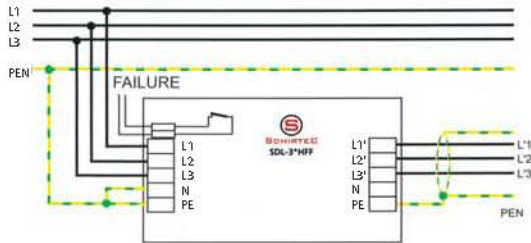

System IT

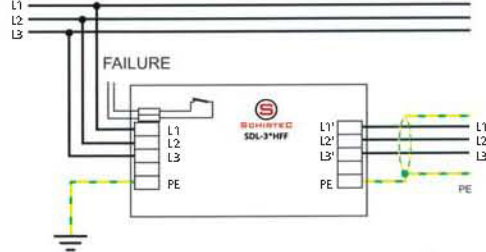

Basic circuit diagram

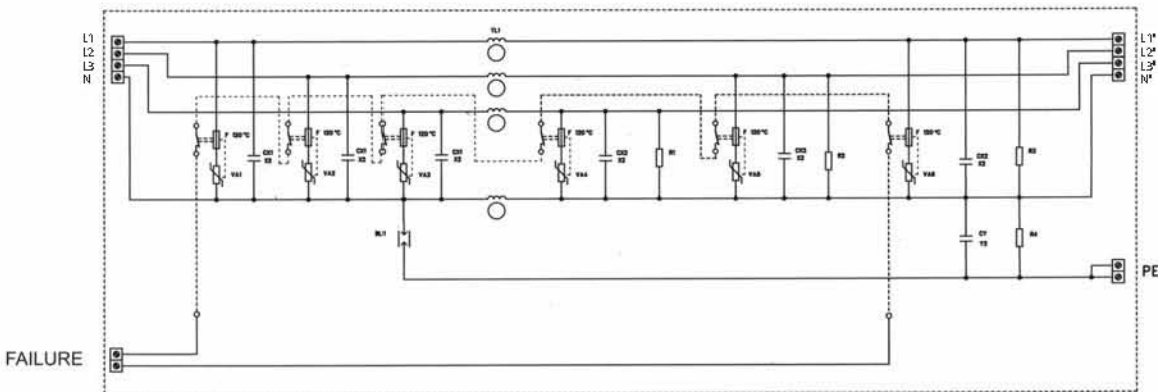

It is recommended to connect protected appliance by appropriately dimensioned shielding conductor. Surge arresters SDL-332HFF,SDL-350HFF,SDL-363HFF,SDL-380HFF in basic version are designed for mounting on chassis by means of 4 screws M4.If mounting on DIN rail is required,it is necessary to specify when placing an order - horizontal/vertical mounting (e.g.SDL-350HFF/DIN/H or SDL-350HFF/DIN/V).

It is necessary to ensure that the ventilation holes in the box of SDL-332HFF, SDL-350HFF, SDL-363HFF, SDL-380HFF are not covered.

The filter contains non-linear elements (varistors and gas discharge tubes),that is why it is necessary to disconnect the filter during controlling of switchboard and measuring of insulation resistance of L.V. supply system.

Recommended cross-section for grounding	
SDL-316HFF	4 mm ² Cu
SDL-325HFF	4 mm ² Cu
SDL-332HFF	6 mm ² Cu
SDL-350HFF	6 mm ² Cu
SDL-363HFF	10 mm ² Cu
SDL-380HFF	25 mm ² Cu

SDL-16/400 HFF

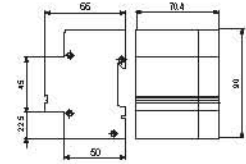

Two-stage ,single-phase protection SDL-16/400 HFFS with a high frequency filter is designed for protection of appliances supplied by voltage 400V (AC,DC) against pulse surges and HF interference.It is intended for the nominal current $I_N=16A$.Mounting on DIN rail 35 mm. This product complies to the IEC 61643-1and EN 61643-11 standards. SDL-16/400HFFS are equipped with special varistors with max. discharge current $I_{max}=8kA(8/20)$, $t_A<25ns$ and special core with a high permeability $\mu>80000$. Function failure of non-linear elements-varistors is indicated by target disconnection of mechanical thermal fuses, which react to varistors overheating above cca 120°C. When one of the three thermal fuses reaches the remote monitoring Failure is disconnected.

Type		SDL-16/400HFFS
Test class according to IEC/EN		III / TT3
Nominal voltage	U_N	400V/50/(60) Hz
Nominal current	I_N	16A
Nominal discharge current $I_n(8/20)$	I_n	5 kA (L/PE)
Response time	t_A	<25ns(L/L2) <100ns(L/PE)
Max. Continuous operating voltage	U_C	480 V/50(60) Hz
Combined impulse	U_{oc}	6 kV (L/PE)
Recommended back-up fuse		16A
Operating temperature range	ϑ	-40°to + 55°C
Cross-section		4+6mm²
Protection type		IP 20
Housing material		SLOVAMID 6FRC2
Mounting on		DIN rail 35mm
Asymmetrical attenuation on filter (band-stop filter) 0,15 to 30 MHz		Min. 80 dB at 4MHz Min. 40 dB in band 0,15 to 30MHz
Filter constants	C_{X2} C_{Y2} L R	M33 22n 1,8 mH M68
Power loss at the temperature of 20°C		<3,5W
Potential free signal contact:		El.strength against internal circuit 3750V_{rms} El.strength against network circuit 3750V_{rms} Insulation resistance 2x10⁷Ω Max. switching current ~0,5A Max. switching voltage ~250V
Leakage current		<3mA
Lifetime		min 100.000 hrs
Weight	m	250g

Protected equipment is recommended to connect with appropriately dimensioned shielded cable.
Recommended cross section for grounding is 6 mm².
The DC version can be produced only on a special demand.

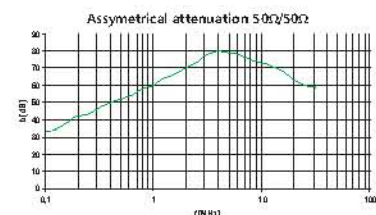

POWER SUPPLY SYSTEMS SURGE ARRESTER CLASS III

SDLTN

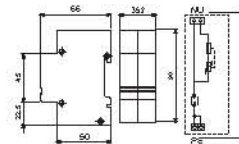

It is a surge protection device designed for universal application for protection of all electrical appliances connected to the L.V. supply systems against impulse surge effects. It is suitable for TNS and TNC systems. It is possible to require this type for different operation voltage, when ordering. The device fulfils requirements of arrester class III according to IEC61643-1 and EN 61643-11 standards. SDLTN is equipped with non-linear elements-varistors with maximum discharge ability $I_{max}=8kA(8/20)$ and special gas discharge tubes with maximum discharge ability $I_{max}=10kA(8/20)$. Potential failure is indicated by a red target of thermal fuse, which reacts to varistor overheating above $120^{\circ}C$ temperature.

Type		SDLTN
Test class according to IEC/EN		III / T3
Applicable for systems		TNS, TNC
Nominal voltage	U_N	230V/50(60)Hz
Max. continuous operating voltage	U_C	275V/50(60)Hz
Nominal discharge current $I_n(8/20)$	I_n	3 kA (L→N, L→PE) 5 kA (N→PE)
Combined impulse	U_{oc}	6 kV (L→N, L→PE) 10 kV (N→PE)
Voltage protection level at U_{oc}	U_p	≤ 1 kV (L→N, L→PE) $\leq 1,2$ kV (L→PE, N→PE)
Response time	t_A	<25ns(L→N) <100ns(L→PE) <100ns(L→PE)
Recom.cross-section of connected conductors		Max. 2,5 mm ²
Weight	m	80g
Protection type		IP 20
Mounting on		DIN rail 35mm
Housing material		SLOVAMID 6FRC2
Operating temperature range	ϑ	-40°to + 80°C
Colour		Grey

Recommended connection of SDLTN

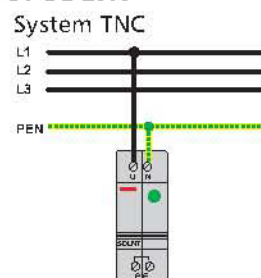
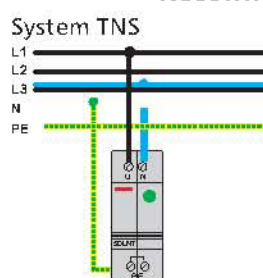

SDL-25RFI

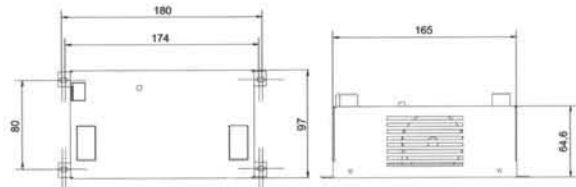

SDL-25RFI is specially designed hybrid low noise filter intended for a high effective protection of expensive electronic equipment against high frequency disturbance and against impulse overvoltage. The combination of fast two-stage protection device and quality frequency filter provides extreme suppression of voltage levels of high-energetic impulses which come into the protected equipment from the L.V. power distribution side. This combination also provides an attenuation of high frequency noise levels in band 0,1 to 100MHz. The filter is equipped with a high power nonlinear components (varistors) with response time $t_A < 25\text{ns}$ and total peak surge current of 48kA (8/20). All fitted varistors are equipped with thermal disconnecters that react to varistors overheating at overload. This device is equipped with optical indicator of right function STATUS INDICATOR and with remote monitoring of failure (FAULT MONITORING) by potential-free switching contact. These filters are constructed to be mounted on DIN rail 35mm or it is possible to fit them with 4 screws straight onto chassis of switchboard. The basic version of SDL-25RFI is for nominal current $I_N = 25\text{A}$ and nominal voltage $U_N = 230\text{VAC}$ (DC). However, we can also offer $U_N = 6, 12, 24, 48, 60, 80, 110, 120, 130, 160\text{VAC}$ (DC) if required.

Type	SDL-25RFI	
Test class according to IEC/EN		III /T3
Nominal voltage	U_N	230V/50(60)Hz
Nominal current	I_N	25A
Max. continuous operating voltage	U_c	275V/50(60)Hz
Total peak surge current of fitted varistors		48kA(8/20)
Test by combined impulse	U_{oc}	6 kV (L→N, L→PE, N→PE)
Voltage protection level at U_{oc}	U_P	<650 V (L→N, L→PE, N→PE)
Response time	t_A	<25ns
Recommended cross-section of connected conductors		4mm ² Cu (L,N,PE) 1mm ² Cu (FAULT MONITORING)
Operating temperature range	ϑ	-40°to + 55°C
Protection type		IP 00
Housing material		Sheet Metal 0,8 mm
Mounting on		by screws M4 on chassis or on DIN rail 35 mm
Asymmetrical attenuation of filter (band-stop filter 0,1-100MHz)		Min. 50 dB in band 1 to 100 MHz 20 to 50 dB in band 0,1 to 1 MHz
Filter constants	C_x C_y L R	220 nF + 3x4, 7μF 2X47 nF (or Acc. to customer's need) 2x1μH+2x44μH 68Ω
Power loss at winding tempature 20°C		29 W
Potential free signal contact:		El.strength against surround. circuits El.strength against network circuit Insulation resistance Max. switching current Max. switching voltage
Life time		min 100.000 hrs
Weight	m	950g

POWER SUPPLY SYSTEMS SURGE ARRESTER CLASS III

Asymmetrical attenuation 50Ω/50Ω

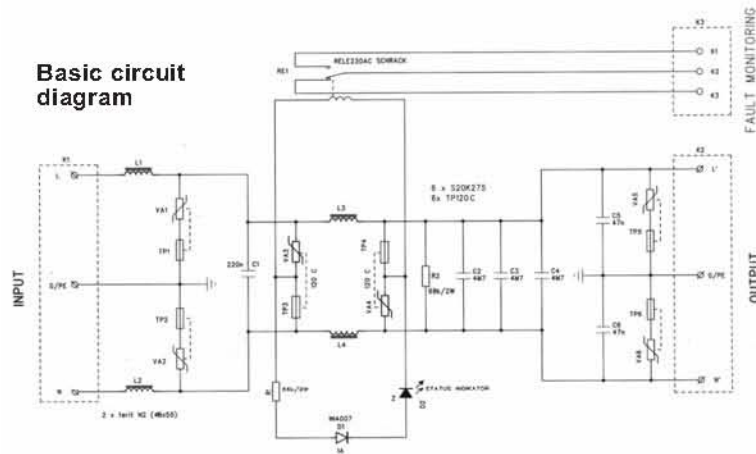
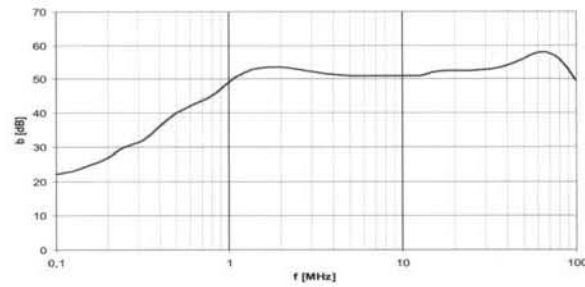

Note 1: Filter SDL-25RFI is in basic version designed for mounting on chassis by means of 4 screws M4. If mounting on DIN rail is required, it is necessary to specify when placing an order horizontal/vertical mounting (e.g. SDL-25RFI/DIN/H or SDL-25RFI/DIN/V).

Note 2: It is necessary to ensure that the ventilation holes in the box of SDL-25RFI are not covered.

Note 3: Filters for nominal voltages $U_N = 6, 12, 24, 48, 60, 80, 120, 130, 160\text{VAC (DC)}$ are produced on a special demand only.

Note 4: The filter contains nonlinear components (varistors), that is why it is necessary to disconnect the filter during controlling of switchboard and measuring of insulation resistance of L.V. supply system.

SDI-16



Basic circuit diagram

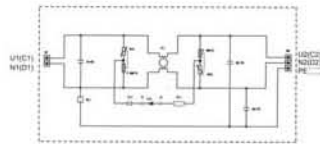

SDI-16 is a socket adaptor designed as so-called transient protection, where protective elements - varistors make two-stage cascade together with decoupling impedance created by current compensated inductor. This inductor is used because it has an absorbing ability during a transient effect initiated by current impulse stroke into an input clamps and it also effectively reduces the level of high-frequency disturbance in transient and reverse direction (in band 0,15 ÷ 30MHz acc. to IEC 939-2) The right function (the integrity of mechanical thermal fuses of non-linear elements - varistors) is indicated by a green led diode.

SDI-16 contains non-linear elements (varistors and gas discharge tubes), that is why, it is necessary to disconnect them from L.V. supply system during controlling the right function of switchboard and during measuring of insulation resistance.

Type		SDI-16
Test class acc. to IEC/EN		III /T3
Nominal voltage	U_N	230 V AC
Max.continuous operating voltage	U_C	275V AC
Nominal current	I_N	16A
Nominal discharge current I_n (8/20)	I_n	3 kA (L→N, L→PE)
Tested by combined impulse	U_{oc}	6 kV (L→N, L→PE)
Voltage protection level at wave shape I_{max} (8/20)	U_p	<840V (L→N) <500V(L→PE)
Response time	t_A	<25ns (L→N) <100ns (L→PE, N→PE)
Recommended cross-section of connected conductors		16A
Operating temperature range	ϑ	-5°to + 40°C
Protection type		IP 20
Asymmetrical attenuation of filter (band-stop filter) 0,15 to 30 MHz		min. 40 dB in band 0,15 to 30 MHz min. 80 dB in band 2,5 MHz
Filter constants	C_x	220 nF
	C_y	22 nF
	L	0,4 mH
Power loss at winding temperature 20°C		<3,5W
Weight	m	180g

POWER SUPPLY SYSTEMS SURGE ARRESTER CLASS III

SZS-1I and SZS-1P

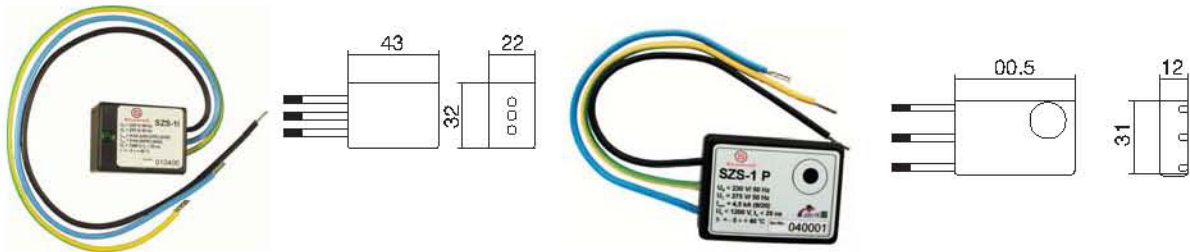

It is intended for mounting into electrical installation systems: underfloor systems, cable ducts and flush-mounted sockets. SZS-1I and SZS-1P are suitable supplements of socket distribution which are protected by SDL-*HFF protector. The right function is optically indicated by a green LED diode (I-type) or by sound of built piezosiren (P-type). SZS-1I and SZS-1P comply with IEC 61 643-1 and EN 61 643-11 standards.

Type		SZS-1I	SZS-1P
Test class according to IEC /EN		III / T3	
Nominal voltage	U_N	230 V/50(60)Hz	
Maximum continuous operating voltage	U_C	275 V/50(60)Hz	
Nominal discharge current $I_n(8/20)$	I_n	3 kA (L→N, L→PE) 5 kA (N→PE)	
Combined impulse	U_{oc}	6 kV (L→N) 10 kV (L+N→PE)	
Voltage protection level at U_{oc}	U_p	≤1 kV (L→N) ≤1,2 kV L(N) →PE	
Response time	t_A	<25 ns(L→N) <100 ns(L→PE) <100 ns(N→PE)	
Operating temperature range	ϑ	-5°C to +40°C	
Fault indication		Control green LED-diode does not shine	By sound of built piezosiren
Recommended back-up fuse		16A	
Cross section of leading lines		max.1,5 mm ²	
Housing according to EN 605 29		IP 20	
Lifetime	m	min 100.000 hrs	

Recommended connection of SZS-1I

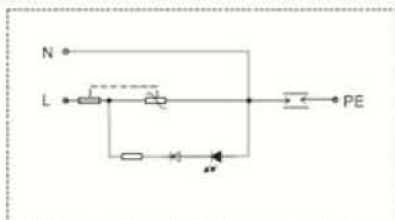

Recommended connection of SZS-1P

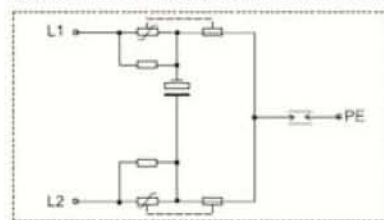

Recommended connection of SZS-1I and SZS-1P

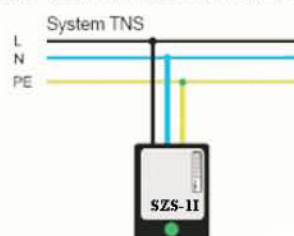

SZS-1.*C, SZS-1.*T



An innovated range of single and double sockets with inbuilt surge protections. The devices protect all kinds of electronic appliances against transverse and also lengthwise surge, which are created in consequences of atmospheric discharges or switching processes in L.V. supply system. They are intended for mounting into installation boxes KU 68 (40mm deep) and BCD 65 (45mm deep). The right function is indicated by a green LED diode (SZS* type), or inbuilt piezosiren (SZS*P type). Screw clamps are used for connection to L.V. supply system. TANGO or CLASSIC models are available in different colour shades.

Type		TANGO	CLASSIC
Test class according to IEC /EN		III / T3	
Nominal voltage	U_N	230 V/50(60)Hz	
Nominal current	I_N	16 A	
Maximum continuous operating voltage	U_C	275 V/50 (60)Hz	
Nominal discharge current $I_n(8/20)$	I_n	3 kA (L→N, L→PE) 5 kA (N→PE)	
Combined impulse	U_{oc}	6 kV (L→N, L→PE) 10 kV (N→PE)	
Voltage protection level at U_{oc}	U_p	≤1 kV (L→N, L→PE) ≤1,2 kV (L→PE, N→PE)	
Response time	t_A	<25 ns(L→N) <100 ns(L→PE) <100 ns(N→PE)	
Operating temperature range	ϑ	-5°C to +40°C	
Fault indication		green led diode (SZS* types) or inbuilt piezosiren (SZS*P types)	
Recommended back-up fuse		16A	
Recommended cross section of connected conductors		max. 2,5 mm ²	
Protection type		IP 20	
Lifetime		min 100.000 hrs	
Colour		white / grape / black / dark-blue	bright-white/ivory/brown/ beige/antracit

SPRO F, SPRO F/TEL, SPRO F/TV



Universal surge protectors type SPRO F reduce a risk of damage of the connected equipment owing to voltage pulses in the distribution network.

They may originate in consequence of a near lightning stroke, switching processes in the power supply system or heavy inductive loads switching (electromotors, inductive furnaces, fluorescent tubes etc.).

These adaptors comply to IEC 61643-1 and EN 61643-11 standards and fulfil conditions of class III. SPRO F contains varistors equipped with a thermal disconnecter, gas discharge tubes and children protectors. The right function is indicated by a green LED diode. Power status is indicated by a red LED diode. It is suitable for office and household applications.

SPRO F/TEL protects telephone signals

SPRO F/TV protects TV signals

Type		SPRO F SPRO F/TEL SPRO F/TV	
		network section	TEL/TV
Test class according to IEC/EN		III / T3	
Nominal voltage	U_N	230V/50(60) Hz	-
Maximum continuous operating voltage	U_C	275V/50(60) Hz	-
Nominal current	I_N	16 A	-
Continuous operating current	I_c	c.2 mA	-
Nominal discharge current $I_n(8/20)$	I_n	2,5 kA	
Combined impulse	U_{oc}	5 kV	
Voltage protection level at $I_n(8/20)$	U_p	≤ 1,5 kV	≤ 300 V
Response time	t_A	< 25 ns	
Recommended back-up fuse		16 A	-
Operating temperature range		-5°C to +40°C	
Housing according to EN 605 29		IP 20	
Lifetime		min. 100.000 hrs	
Weight	m	126 g	