

INFORMATION TECHNOLOGY SYSTEMS

SD, SDB, SDB/R and SDE

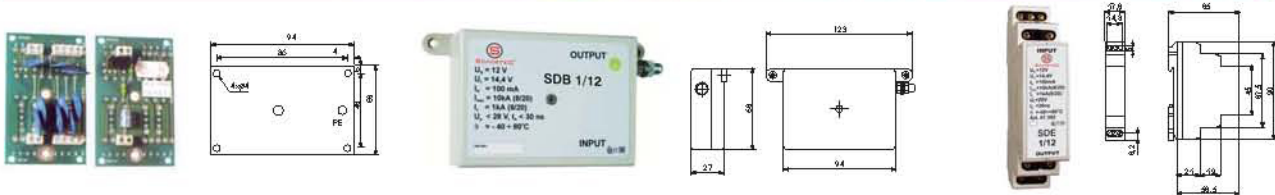

SD* is a complex range of surge protection devices designed for protection of data, communication, measuring and control lines against surge effects in the Lightning Protection Zones Concept at the boundaries of LPZ O_{A(B)}-1 and more, according to IEC 1312-1. All types provide effective protection of connected equipment against transverse and lengthwise surge effects according to IEC 61643-21. Models:

SD, SDNV 0,5A and **SDNV 5A** are complete printed circuit boards, **SDB, SDB/R, SDNVB 0, 5A** and **SDNVB** are possible to be screwed on a wall (provided in a plastic housing) **SDE, SDNVE 0,5 A** and **SDNVE 5A** are intended for application in measuring and control systems, mountable on DIN rail 35mm.

For the protection of telecommunication lines it is recommended to order the type with nominal voltage $U_N = 170V$ or with the code mark D.

Use	Protection of tel.lines and data transmission				Protection of supply mains 0,5A			Protection of supply mains up to 5A		
	SD	SDB	SDE	SDB/R	SDNV	SDNVB	SDNVE	SDNV	SDNVB	SDNVE
Max.number of fitted pairs	1-4		1-2	RJ45 1-4 RJ12 1-2	1-4		1-2	1-4		1-2
Recommended cross-section of connected conductors	1,5mm ²			0,3 mm ²	1,5mm ²			1,5mm ²		
Nominal voltage	U_N	6;12;24;48;170 V			6;12;24;48V		24;30;48; 80V	12;24;48;80; 110V		12;24;48; 80V
Max.continuous operating voltage	U_C	7,2;14,4;28,6;57,6;204V			7,2;14,4;28,6; 57,6 V		28,6;36; 57,6;96 V	14,4;28,6;57,6; 132V		14,4;28,6; 57,6;96V
Nominal current	I_N	100mA			0,5A			5A		
Series impedance		1,5 to 10Ω(on demand of a customer)			4,7 μH			zero		
Parasitic capacitance	C	1,5nF				10nF				
Maximal discharge current $I_{max}(8/20)$	I_{max}	10kA (type L20kA)		2kA	10kA (type L 20kA)			2kA for $U_N=12;24;48V$ 6,5kA for $U_N=80V$ 8kA for $U_N=110V$		
Nominal discharge current (8/20)	I_n	1kA								
Voltage protection level at I_n	U_p	15,28,64,160,500V			15,28,64,160V		64,75,85, 500V	56,90,170, 280,400V		56,90,170, 280V
Voltage protection level at 1kV/μs	U_p	9,18,34,66,260V			9,18,34,66V		34,54,66, 120V	27,50,118, 200,310V		27,50,118, 200V
Response time	t_A	<30ns				<25ns				
Data rate		min. 10MBit/s				-				
Operating temperature range	ϑ	-40°to + 80°C								
Protection type		IP00	IP20		IP00	IP20		IP00	IP20	
Category tested in accordance with IEC 61643-21:2000		A2, B2, C2, C3, D1								

SD 2/100M 5cat



Complex range of surge protection devices designed for faultless data transfer with in computer networks category 5. They protect input electronic circuits of network cards against damage caused by surge effects in the Lightning Protection Zones Concept at the boundaries of LPZ O_{A(B)}-1 and more, according to IEC 1312-1. It is recommended to use these protection devices at the input of a protected equipment.

Models:

SPSK*/100 5 cat printed circuit board intended for mounting into SPSK 10, it is suitable for installation in 19" rackmounts SPSK 2/100M 5 cat designed for protection of two pairs has LSA-Plus connector on the input side and RJ45 connector on the output side. SD */100M 5 cat is suitable for mounting on a wall. SD 2/100M 5 cat protects two pairs and SD 4/100M 5cat protects four pairs of conductors in the category 5 computer network.

Type		SPSK 2/100 5 cat SPSK 4/100 5 cat	SD 2/100M 5 cat SD 4/100M 5 cat
Insertion impedance		1,5Ω	
Characteristic impedance		100 Ω	
Insertion loss		<23,2 dB (at 100MHz)	
Attenuation crosstalk ratio (ACR)		Min.4dB (at 100MHz)	
Dual next crosstalk		Min.24dB (at 100MHz)	
Transfer speed		Max.100MBit/s	
Nominal current	I _N	300mA	
Nominal voltage	U _N	6V	
Max discharge current I _{max} (8/20)	I _{max}	10kA 2kA	2kA 2kA
Nominal discharge current I _n (8/20)	I _n	1kA	
Voltage protection level at I _n	U _P	10V	
Voltage protection level at 1kV/μs	U _P	<10V	
Parasitic capacity	C	<42pF	
Response time	t _a	<25ns	
Category tested in accordance with IEC 61643-21:2000		A2, C2, C3, B2, D1	
Input/Output		LSA-PLUS/RJ45 RJ45/RJ45	RJ45/RJ45 RJ45/RJ45
Number of protected pairs		2 for SD 2* and SPSK 2* 4 for SD 4* and SPSK 4*	
Operating temperature range	θ	-40°to + 80°C	

SCHIRTECNET 4/250M 6 cat

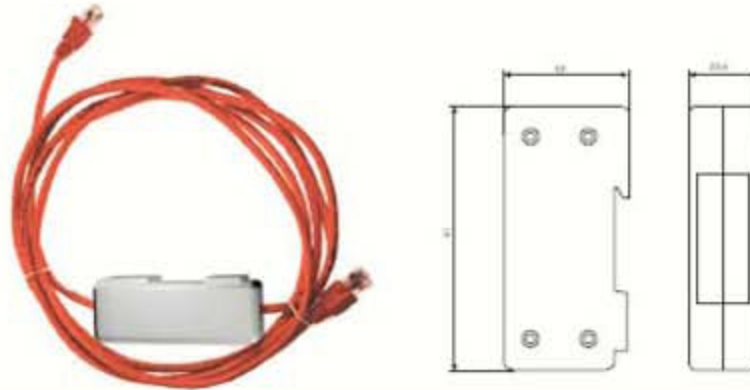

SCHIRTECNET 4/250M 6 cat is designed to protect 5E/6 data and communications lines running at 100 Base-T transmission speeds.

All pins of 4 data lines are protected by TRANSIL elements with extra-sharp clamping response which permanently eliminates transients from given locality in wide area of network applications. SCHIRTECNET 4/250M 6cat consists of a plastic box and leading lines which are terminated with RJ-45 connectors. Length of these lines (a,b) are to be specified by customer.

Type		SCHIRTECNET 4/250M 6 cat
Mode of protection		L-L,L-G(PE)
Number of protected data pairs		4
Frequency handling		up 250 MHz
Nominal voltage	U_N	6 V
Peak pulse current at vavre shape 10/1000 μ s	I_{imp}	130 A
Data clamp voltage	U_p	< 7,5 V
Voltage protection level at 1kV/ μ s	U_p	< 15 V
Response time	t_A	< 5 ns
Maximum capacitance	C	< 5pF
Connectors		9&1' Patch Cords
Mounting		DIN rail 35 mm
Grounding method		through DIN rail 35 mm by special metal clasp on back side of box
Length of leading lines	a/b	acc.to customer's specification



SSPD-TESTER-1**Equipment accessories:**

1. 1 piece of network line
2. 1 piece of 3kV high voltage probe
3. 1 piece of jumper cable
4. 1 piece of safety crocodile clip

Portable service equipment intended for a quick diagnostics of operation efficiency of SPDs - class III, the device can be also used for a quick orientation control of SPDs condition - class I and II.

Advantages of the tester:

- a quick diagnostics of SPDs
- it optimally loads SPDs during tests so it does not lessen their lifetime
- used for servicing activity
- simple service

Tests:

- residual voltage
- disconnected arrester
- short-circuited arrester

Source resistance:

- 100 Ω for 1kV range
- 200 Ω for 2kV range
- 300 Ω for 3kV range

Technical parameters:

- Supply voltage: 230V \pm 10%, 50Hz
- Output voltage: optional switched 1kV, 2kV, 3kV at a test impulse waveshape 1,2/50 μ s
- Weight: 3kg
- Supply: max. 50VA

Indication of the output voltage:

By the column display made out of 30 LED diodes (one LED diode switching on refers to level growth of the output voltage by step 100V).

Calibration of the column display:

The calibration is carried out by the potentiometer CALIBRATION, when MEASUREMENT button is pressed and output is unloaded. The calibration is carried out by switching on the 1st decade (0÷1kV) of display in 1kV range, it is carried out by switching on the 1st and 2nd decade (0÷2kV) in 2kV range and by switching on the 1st, 2nd and 3rd decade (0÷3kV) in 3kV range. The last diode in the top decade may glimmer during the calibration.

Measurement:

The measured arrester must be disconnected from supply conductors before measuring. The clamp (-) of tester is connected to one pole of the tested arrester by safety crocodile clip and a blue jumper cable. The terminal of the high voltage probe should be pushed in the clamp (+) of tester and you should apply its tip to the second pole of tested arrester by your hand. The button MEASUREMENT should be pressed by the other hand and then you should watch the data on the display for approximately two seconds. After reading the data you can release the button MEASUREMENT. The data match the residual voltage of the measured protective element with accuracy \pm 100V.

Protective units of class I are typically measured in 3kV range.

Protective units of class II are typically measured in 2kV range.

Protective units of class III are typically measured in 1kV or 2kV range depending on the fitted protective elements.

SSPD-TESTER-2



This impulse tester is especially constructed for diagnostics of operation efficiency of installed SPDs – class III in all kinds of communication, data and coaxial systems.

Advantages of the tester:

- a quick diagnostics of SPDs
- used for regular control activity
- simple service

Tests:

- residual voltage of the surge protection devices
- interruption of the surge protection devices
- short-circuit of the surge protection devices

Technical parameters:

Supply voltage: $230V \pm 10\%$, 50Hz

Supply: max. 20VA

Output voltage: 1kV at a test impulse waveshape 1,2/50 μ s

Source resistance: 100 Ω

Output voltage indication: in 300V, 60V, 30V switching range by the 30 LED diodes column display.

Evaluation accuracy: <3 modules

Dimensions: 222x198x71mm

Weight: 2,5kg

Note: SSPD-TESTER-2 must be equipped with the adaptor SX 2.10 and the consequential accessories.

Installation instructions:

1. Connect the tester to the supply voltage
2. The switch RANGE should be switched over to CALIBRATION position
3. Switch the tester on
4. Press the button MEASUREMENT and set glimmering of the last LED diode at the column evaluating display by potentiometer CALIBRATION
5. Choose the range according to SPD type and catalogue maximum residual voltage by the switch with 300V, 60V, 30V range
6. Connect appropriate connecting adaptor to the tester's output according to controlled SPD and connect to SPD's input
7. Connect appropriate connecting adaptor to the tester's input according to controlled SPD and connect to SPD's output
8. Press MEASUREMENT button and read the residual voltage values on the display after stabilization
9. In case of SPD disconnecting, two lowest LED diodes at the display light up. In case of SPD short-circuiting, the display doesn't light up. In case of SPD protective elements disconnecting, the whole display lights up.

ADAPTOR SX 2.10

Connection of ADAPTORSX 2.10 to SSPD-TESTER-2 and DATA SOCKET

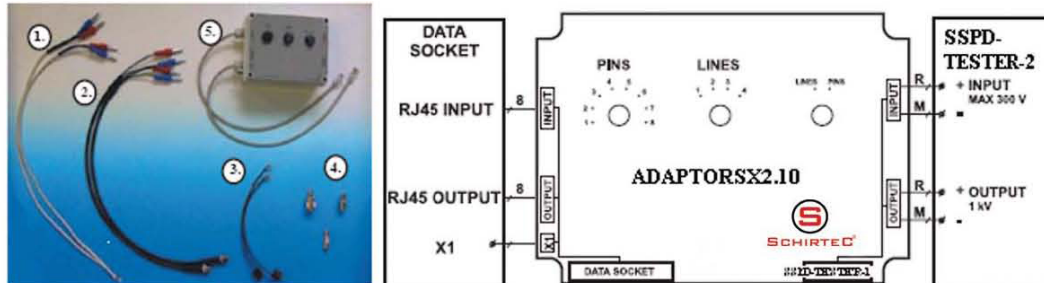

Recommended accessories obtainable when placing a special order

1. Connecting cables for control of SPD with the terminal block
2. Connecting cables for control of SPD with BNC connectors
3. A connecting reducer for control of SPD with RJ12/RJ45 connectors
4. A reducer of BNC/N connector
5. The adaptor SX 2-10 for control of SPD with RJ45 connectors

ADAPTOR SX 2.10

Optional equipment of SSPD-TESTER-2 designed for control of data SPD fitted with RJ45 connector at the input and output (or it can be fitted with RJ12 connector when using transient reduction).

Warning:

1. Do not stretch the input or output cable fitted with RJ 45 connectors!
2. In the case that each line of SPD is not fitted, the testing impulses are induced into unloaded supplies during the control and 2 – 3 segments of LED display could light up at the LED indicator.

Advantages of adaptor:

- a quick control of up to four lines in SPD
- a quick control of particular pins in SPD
- simple service

Installation instructions:

The adaptor is intended for control of SPDs fitted with RJ45 and RJ12 connectors.

1. Connect the adaptor to the input and output of the SSPD-TESTER-2 by means of cables with BNC connectors.
2. RJ45 connectors at the adaptor connect to the input and output of SPD
3. Connect the grounding clamp of SPD to X1 clamp at the adaptor
4. Switch FUNCTION button to LINES position and control the clearness of particular lines and the residual voltage at the output according to the type of SPD by switching over LINE 1-4 switch
5. Switch FUNCTION button to PINS position and by PINS 1-8 switch control the residual voltage of particular pins in comparison with grounding clamp

Installation instructions for ADAPTOR SX 2.10 when checking telephone SPDs

1. Attach the cable reductions RJ45 to RJ12
2. Connect RJ12 connectors into the telephone SPD
3. The switch on ADAPTOR SX 2.10 should be in LINES and LINES 1 position
4. Switch the range switch at SSPD-TESTER-2 over to 300V range
5. Press the measuring button and read the residual voltage on the display, suitable SPD fulfils $U_p = 200V \pm 10\%$
6. Turn the switch of ADAPTOR SX 2.10 into PINS position
7. Switch the range switch of SSPD-TESTER-2 over to 60V range
8. Interconnect X1 point on ADAPTOR SX 2.10 with PE clamp of the telephone SPD
9. Press MEASUREMENT button and read the residual voltage, when the switch of ADAPTOR SX 2.10 is in PINS 1 position and then PINS 2 position. Suitable SPD fulfils $U_p = 30$ to $40V$

COMPUTER NETWORK PROTECTION

SCHIRTECNET

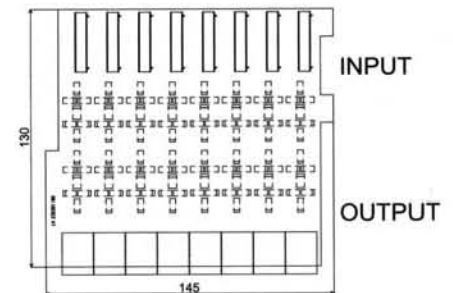
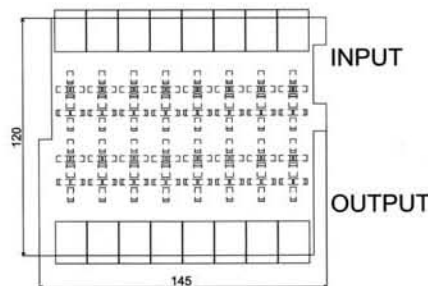
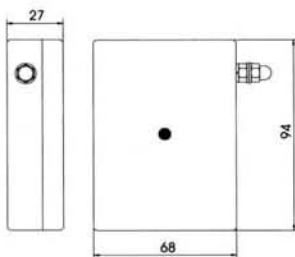
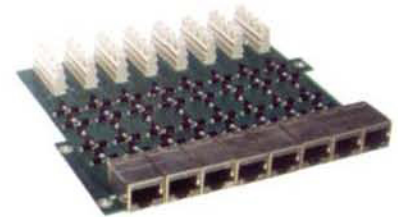
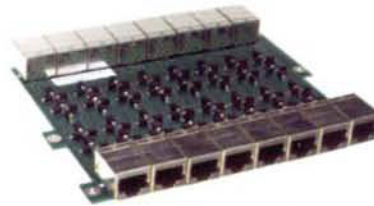

SCHIRTECNET is a complex range of protection devices specially designed for faultless data transfers within computer networks concerning the 5th category. They protect input electronic circuits of network cards against damage caused by surge effects in the Lightning Protection Zones Concept at the boundaries of LPZ O_{A(B)}-1 and more, according to IEC 1312-1. It is recommended to use these protection devices at the input of a protected equipment.

Schirtec offers the following models:

SCHIRTECNET 1.2RJ/RJ protects one line with two protected pairs, it is available in a plastic housing, which enables screwing on a wall, also available with double-sided adhesive tape, which enables attaching to the protected appliance. There is RJ45 connector at the input and output of the device.

SCHIRTECNET 8.4RJ/RJ and SCHIRTECNET 8.4LSA/RJ types are designed for protection of eight lines with four protected pairs. They are constructed as fitted print-circuit boards to be mounted into the metal SPSK 24 panel.

SCHIRTECNET 8.4RJ/RJ-RJ45 connectors are at the input and output of the device. SCHIRTECNET 8.4LSA/RJ-LSA-PLUS connectors are at the input and RJ45 connectors at the output. SPSK 24 is a metal panel suitable for fitting in 19" rack mounts.

Type SCHIRTECNET		1.2 RJ/RJ	8.4 RJ/RJ	8.4 LSA/RJ
Characteristic Impedance		100 Ω		
Insertion Loss		<23,2 dB (at100 MHz)		
Attenuation Crosstalk Ratio (ACR)		Min. 4dB (at100 MHz)		
Dual Next Crosstalk		Min. 24dB (at100 MHz)		
Transfer Speed		Max. 100 Mbit/s		
Nominal Current	I_N	300mA		
Nominal Voltage	U_N	6V		
Nominal Discharge Current $I_n(8/20)$	I_n	300A		
Voltage Protection Level at I_n	U_P	25V		
Voltage Protection at 1kV/ μ s	U_P	<10V		
Parasitic Capacity	C	<47pF		
Response Time	t_A	<25ns		
Input/Output		RJ45/RJ45		LSA-PLUS/RJ45
Category Tested in Accordance with IEC 61643-21:2000		A2, B2, C2, C3, D1		
Number of Protected Pairs		1x2 pairs	Max.8x4 pairs	
Operating Temperature Range	ϑ	-40°to + 80°C		

SPSK 24

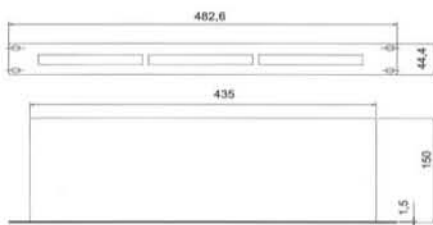

Basic circuit diagram

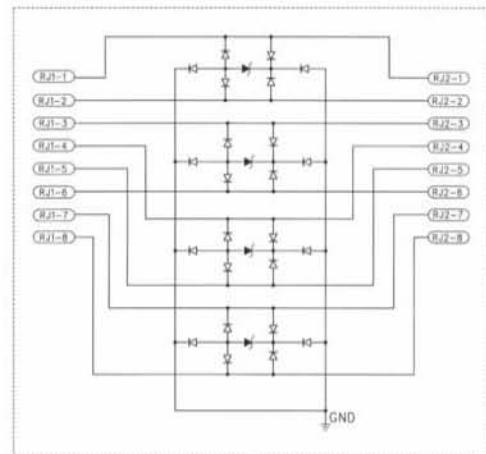

It is a metal panel suitable for fitting in 19" rack mounts. Up to 3 pieces of SCHIRTECNET 8.4 can be mounted into this panel.

SCHIRTECTEL*

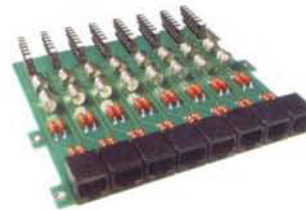

SCHIRTECTEL* is a complex range of protection devices specially designed for the protection of analog telecommunication appliances against surges. The recommended use is in the Lightning Protection Zones Concept at the boundaries of protection zones LPZ 0_{A(B)}-1 and more, according to IEC 1312-1.

SCHIRTECTEL* protects one line with two protected pairs, it is available in a plastic housing, which enables screwing on a wall, also available with double-sided adhesive tape, which enables attaching to the protected appliance. There is RJ45 connector at the input and output of the device. The number of protected pairs of each telephone lines is optional (1 or 2 pairs).

Basic circuit diagram
SCHIRTECTEL 1.2

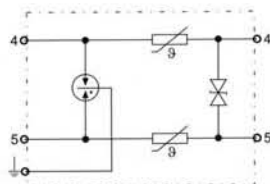

Basic circuit diagram
SCHIRTECTEL 1.4

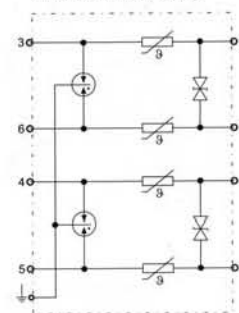

Type SCHIRTECTEL		8.1 RJ/RJ	8.2 RJ/RJ	8.1 XC/RJ	8.2 XC/RJ
Max. Continuous Operating Voltage	U _C	170V DC			
Nominal Current	I _N	150mA			
Nominal Discharge Current at Wave Shape I _n (8/20)	I _n	2,5kA/Line		5 kA/Line	
Voltage Protection Level at I _n Line/Line Line/PE	U _P	<250 V		<275 V	
		<600 V			
Voltage Protection Level at 1kV/μs Line/Line Line/PE	U _P	<230V			
		<600V			
A.C Current (50Hz, 1s)		5 A			
Response Times Line/Line Line/PE	t _A	<1ns			
		<100ns			
Data Rate		Min. 10 Mbit/s			
Insertion impedance	R	10 Ω			
Parasitic capacity Line/Line Line/PE	C	300pF			
		15pF			
Operating Temperature Range	θ	-40°to + 80°C			
Arrester Class According to IEC 61643-21:2000		A2, C2, C3, B2,D1			
Connections Input Output		RJ45		LSA-PLUS	
		RJ45		RJ45	
Protection Type		IP00			
Lines assignment		4/5	3/6, 4/5	4/5	3/6, 4/5